



50 ~ 500 mW Output

Low Divergence, Low Noise

High Efficiency, Compact

System Specifications	DIRL 1450-500
Wavelength	1450 +/- 10 nm
Output Power	50 ~ 500 mW
Beam Diameter at the aperture	~ 5x8 mm
Beam Profile	Near Round
Beam divergence	<3.0 mrad
M ² factor	< 20
Beam Height (mm)	25 mm
Operating Temperature	10-35°C
Point stability after warm-up	<0.05 mrad
Polarization ratio	> 50:1
Power stability (4 Hrs)	< 1%, 3%, 5%
Warm-up time (Minutes)	< 5
TTL Modulation	Optional (upto 30 KHz)
Analog Modulation	Optional (upto 30 KHz)
Power Supply	80 - 260 VAC
Expected lifetime	10,000 hours
Warranty time	1 Year
Dimension (Laser Head)	140 × 75 × 45 mm
Dimension (Power Supply)	154 × 160 × 95 mm
Weight (Laser Head)	0.6 KG
Weight (Power Supply)	1.5 KG

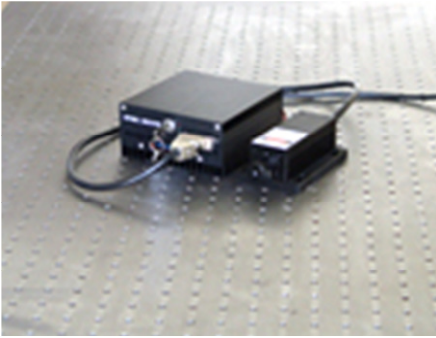

Laser Head



136(L)×73(W) ×50(H) mm³, 0.6kg

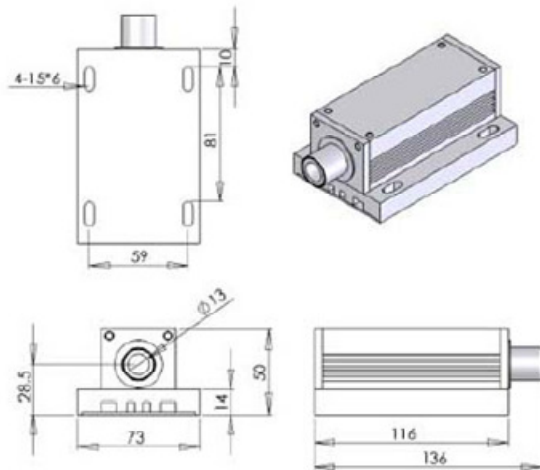

Power Supply



154 (L) ×155(W) ×95 (H) mm³, 1.5kg

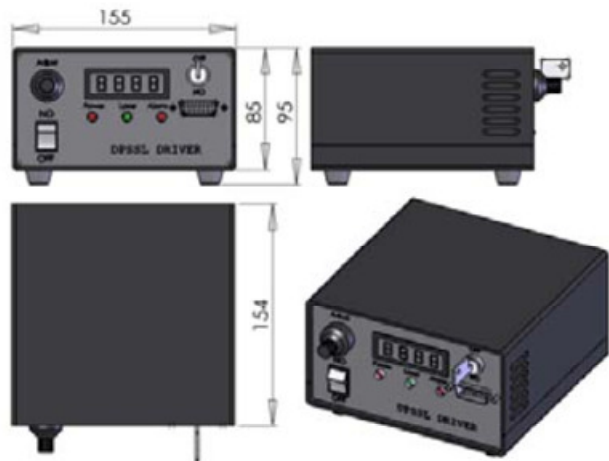

All Dimensions are in mm

Laser Lab Components, Inc. (LLCI) follows a policy of continuous product improvement. Specifications are subject to change without notice.

LLCI offers a limited warranty for all GL™ systems. For full details on warranty coverage, please refer to the Service and Support section at www.LaserLabComponents.com, or contact your local Sales or Service Representative.

www.LaserLabComponents.com^d

